

Bocinas

Horns



Miguel Yuste, 50
28037 Madrid
Telf. +34 913 756 730
 +34 619 643 505

amadini.net

Edición 10/25

Bocinas Electromagnéticas CARACOLA

Bocina unitaria electromagnética, con soporte incluido.

| Ref. | Ø | Polos | Tono | V | Amp. | dB | Hz |
|----------------|-------|-------|-------|-----|------|---------|--------|
| DG-B001 | 90 mm | 2 | Agudo | 12v | 6A | 105-118 | 510±20 |
| DG-B002 | 90 mm | 2 | Grave | 12v | 6A | 105-118 | 410±20 |
| DG-B003 | 90 mm | 1 | Agudo | 24v | 3A | 105-118 | 510±20 |
| DG-B004 | 90 mm | 1 | Grave | 24v | 3A | 105-118 | 410±20 |
| DG-B005 | 80 mm | 2 | Agudo | 12v | 6A | 108-118 | 500±20 |
| DG-B006 | 80 mm | 2 | Grave | 12v | 6A | 108-118 | 420±20 |

Juego de bocinas electromagnética, tono agrudo + grave, con relé y soporte incluido

| Ref. | Ø | Polos | Tono | V | Amp. | dB | Hz |
|-------------------|-------|-------|-------------|-----|-------|---------|---------------|
| DG-B001/02 | 90 mm | 2 | Agudo+Grave | 12v | 6A+6A | 105-118 | 510±20/410±20 |
| DG-B003/04 | 90 mm | 1 | Agudo+Grave | 24v | 3A+3A | 105-118 | 510±20/410±20 |
| DG-B005/06 | 80 mm | 2 | Agudo+Grave | 12v | 6A+6A | 108-115 | 500±20/420±20 |

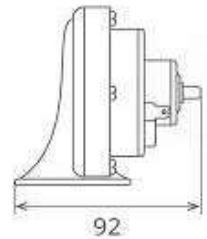
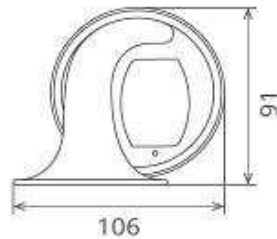

Bocinas Electromagnéticas PLATO

Bocina unitaria electromagnética, con soporte incluido.

| Ref. | Ø | Polos | Tono | V | Amp. | dB | Hz |
|----------------|-------|-------|-------|-----|------|---------|--------|
| DG-B020 | 90 mm | 2 | Agudo | 12v | 6A | 105-118 | 435±20 |
| DG-B021 | 90 mm | 2 | Grave | 12v | 6A | 105-118 | 335±20 |
| DG-B022 | 90 mm | 2 | Agudo | 24v | 3A | 105-118 | 435±20 |
| DG-B023 | 90 mm | 2 | Grave | 24v | 3A | 105-118 | 335±20 |
| DG-B024 | 90 mm | 1 | Agudo | 12v | 6A | 105-118 | 435±20 |
| DG-B025 | 90 mm | 1 | Grave | 12v | 6A | 105-118 | 335±20 |

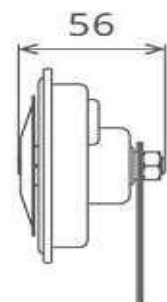
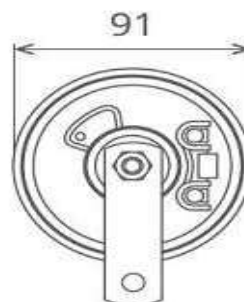

Bocinas Electromagnéticas PLATO

Juego de bocinas electromagnética, tono agudo + grave, con relé y soporte incluido

| Ref. | Ø | Polos | Tono | V | Amp. | dB | Hz |
|----------------|-------|-------|-------------|-----|-------|---------|---------------|
| DG-B030 | 90 mm | 2 | Agudo+Grave | 12v | 5A+5A | 105-118 | 435±20/335±20 |
| DG-B031 | 90 mm | 2 | Agudo+Grave | 24v | 3A+3A | 105-118 | 435±20/335±20 |
| DG-B032 | 90 mm | 1 | Agudo+Grave | 12v | 5A+5A | 105-118 | 435±20/335±20 |

Juego de bocinas **SUPERSONICA** electromagnética, tono agudo + grave, con relé y soporte incluido

| Ref. | Ø | Polos | Tono | V | Amp. | dB | Hz |
|----------------|--------|-------|-------------|-----|-------|---------|---------------|
| DG-B033 | 132 mm | 2 | Agudo+Grave | 12v | 5A+5A | 105-118 | 390±30/320±30 |
| DG-B034 | 132 mm | 2 | Agudo+Grave | 24v | 3A+3A | 105-118 | 390±30/320±30 |



Bocina unitaria electromagnética, con soporte incluido para **MOTOCICLETA**

| Ref. | Ø | Polos | Tono | V | Amp. | dB | Hz |
|----------------|-------|-------|-------|-----|------|---------|-------------|
| DG-B035 | 90 mm | 2 | Agudo | 12v | 1,5A | 105-118 | 480 Hz ± 20 |

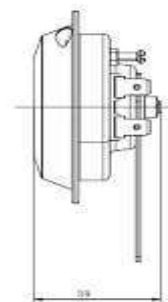
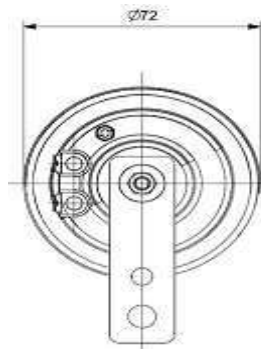

Alarma de Retroceso

Avisador de marcha atrás, para vehículos ligeros y pesados

| Ref. | V | dB | Amp. |
|----------------|--------|-----|-------------|
| DG-B040 | 9v-48v | 110 | 0,1A - 0,6A |



Bocinas Electroneumáticas con Compresor

Bocina electroneumática de 2 y 3 cornetas de plástico rojo de alta resistencia
Incluye compresor, relé tubo y accesorios de montaje

| Ref. | Cornetas | V | Tono | Amp. | dB | Presión |
|----------------|----------|-----|------------------|------|-----|-----------------------|
| DG-B050 | 2 | 12v | Conjunto | 21 | 115 | 12 Kg/cm ² |
| DG-B051 | 2 | 24v | Conjunto | 21 | 115 | 12 Kg/cm ² |
| DG-B053 | 3 | 12v | Conjunto/Alternó | 21 | 115 | 12 Kg/cm ² |
| DG-B054 | 3 | 24v | Conjunto/Alternó | 21 | 115 | 12 Kg/cm ² |

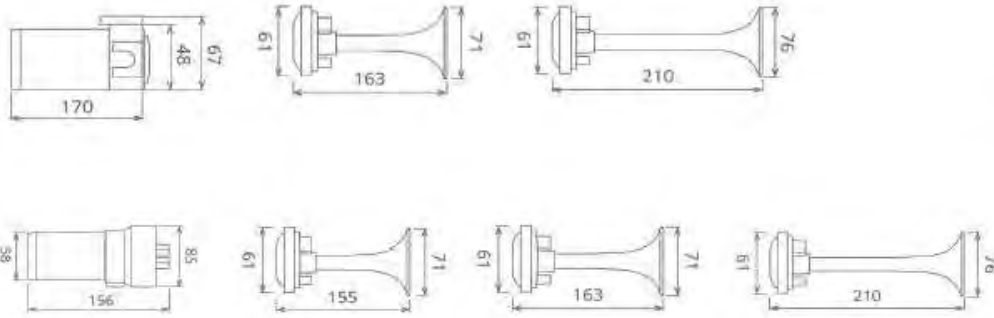

Bocina de 2 cornetas de metal cromadas. Incluye compresor y accesorios de montaje

| Ref. | Cornetas | V | Tono | Amp. | dB | Presión |
|----------------|----------|-----|---------|------|-----|-----------------------|
| DG-B056 | 2 | 12v | Alternó | 21 | 115 | 12 Kg/cm ² |

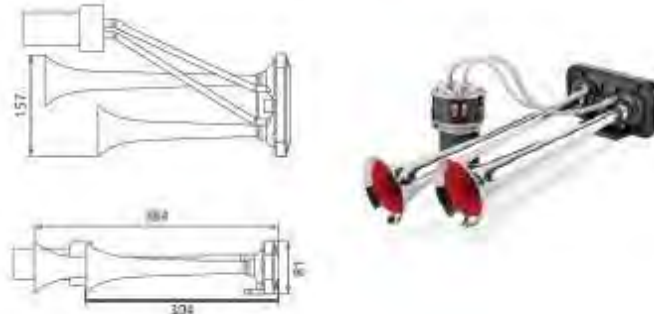

Compresor

Compresor para la activación de bocinas neumáticas con 2 o 3 bocinas

| Ref. | V | Amp. | Presión | Polos |
|----------------|-----|------|-----------|-------|
| DG-B060 | 12v | <17 | 1.000 kPa | 2 |
| DG-B061 | 24v | <9 | 1.000 kPa | 2 |



Bocina especial Venta Ambulante

Bocina electroneumática de 2 tonos, sonido potente. Incluye compresor

| Ref. | Polos | V | Hz | dB | Amp. |
|----------------|-------|----|------------|-----|------|
| DG-B070 | 2 | 12 | 530+670 Hz | 115 | <17 |
| DG-B071 | 2 | 24 | 530+670 Hz | 115 | <9 |

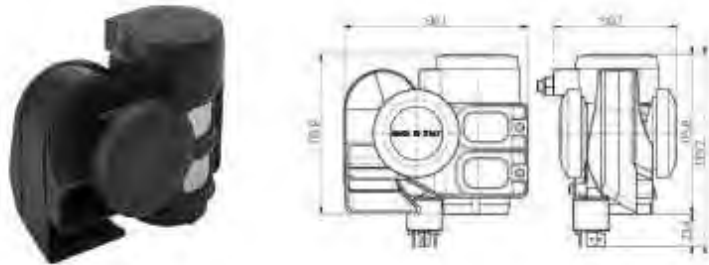

Bocinas de Aire

Bocina de aire con electroválvula, incluye soporte

| Ref. | V | Amp. | Presión | dB |
|----------------|-----|------|----------------------|-----|
| DG-B099 | 12v | 2 | 6 Kg/cm ² | 125 |
| DG-B100 | 24v | 1 | 6 Kg/cm ² | 125 |

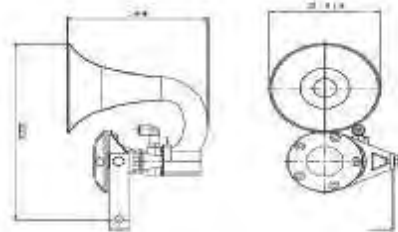

Bocina de 2 cornetas rojas metálica para montaje exterior, con sonido potente. Incluye electroválvula

| Ref. | Tono | V | Presión | dB | Amp. | Bares |
|----------------|----------|-----|----------------------|-----|------|-------|
| DG-B101 | Conjunto | 12v | 6 Kg/cm ² | 125 | 2 | 2/0 |
| DG-B103 | Conjunto | 24v | 6 Kg/cm ² | 118 | 1 | 2/0 |

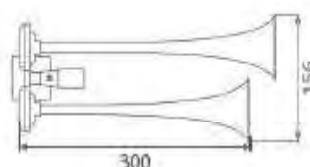
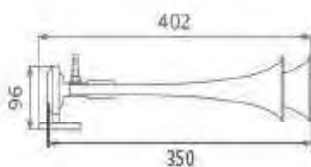

Bocinas de Aire

Bocina musical neumática de aire comprimido, 3 cornetas cromadas, con electroválvula y relé.

| Ref. | Tono | V | Presión | dB | Amp. |
|----------------|------------|----|----------------------|-----|------|
| DG-B110 | 8 melodías | 12 | 6 Kg/cm ² | 125 | 2 |
| DG-B111 | 8 melodías | 24 | 6 Kg/cm ² | 125 | 2 |

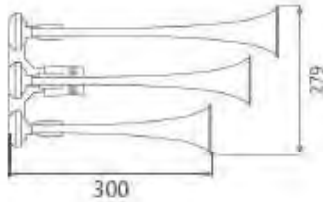
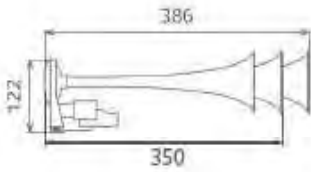

Bocina de aire comprimido de acero inoxidable con embellecedor y tapa frontal para montaje exterior

| Ref. | Largo total | dB | Hz | Presión | Amp. |
|----------------|-------------|-----|--------|----------------------|------|
| DG-B123 | 673 mm | 116 | 170 Hz | 300 – 1200 kPa | |
| DG-B125 | 637 mm | 118 | | 6 Kg/cm ² | 5-10 |

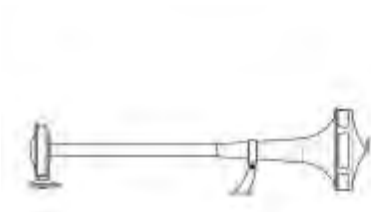

Accesorios

| Ref. | | V | Conexión | Amp. | Polos |
|----------------|----------------|-----|----------|------|-------|
| DG-B200 | Electroválvula | 12v | 8mm | | |
| DG-B201 | Electroválvula | 24v | 8mm | | |
| DG-B202 | Relé | 12v | | 30 | 4 |
| DG-B203 | Relé | 24v | | 30 | 4 |



Bocinas de Aire POLI

Bocina neumática de aire comprimido de 2 y 3 cornetas, metal cromado con pisón incluido.
Para vehículos con sistema neumático

| Ref. | dB | Presión | Tono |
|-------------|---------|----------------------|----------|
| PA 2 | 105/108 | 6 Kg/cm ² | Conjunto |
| P 3 | 125 | 6 Kg/cm ² | Conjunto |



Ref.
BP 4 Pisón para todos los modelos de bocinas neumáticas y convertibles
Conexiones 10mm

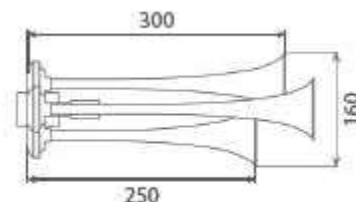
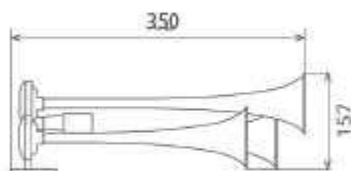
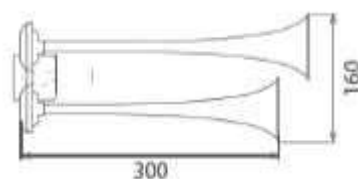
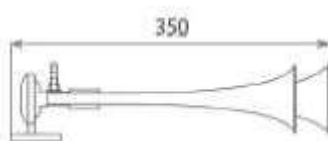



amadini

- 📷 @amadini_sa
- ☎️ (+34) 913 756 730
- 📞 (+34) 619 643 505
- ✉️ info@amadini.net
- 📍 Miguel Yuste 50, 28037 - Madrid

amadini.net

Todos los derechos reservados:

No se permite copiar, reproducir ni transmitir esta publicación de ninguna forma o medio electrónico, mecánico, de fotocopia, grabación o cualquier otro modo, sin autorización expresa de AMADINI, S.A.

Aunque hemos tomado todas las precauciones necesarias al elaborar esta publicación, AMADINI no se responsabiliza de las inexactitudes que puedan aparecer en la misma.